

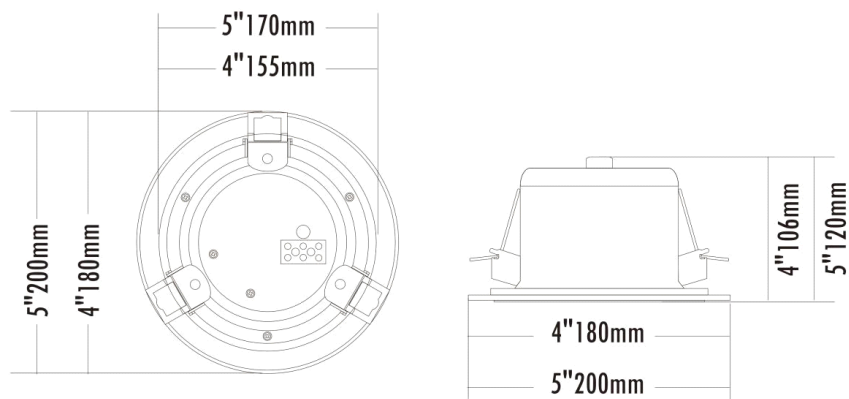

# Fireproof Ceiling Speaker

## VA-504/VA-505



### Descriptions:

\* Indoor with flame retardant iron back cover full audio ceiling speaker, fireproof design, spring presser foot system, convenient for user installation.  
Application: fire fighting, shops, supermarkets, hotels, etc.

### Specifications:

	VA-504	VA-505
Model	VA-504	VA-505
Power Taps @100V	6W	6W
Power Taps @70V	3W	3W
Impedance	COM/1.7KΩ	COM/1.7KΩ
SPL(1W/1M)	89dB	90dB
Frequency Response (-10dB)	90-20KHz	80-20KHz
Speaker Driver	4" x 1	5" x 1
Cutout Size	155mm	170mm
Dimension	180 x 106mm	200 x 120mm
Weight	0.9Kg	0.9Kg